



THE FUTURE OF THE
RIGHT TO REPAIR
& FREE SOFTWARE

LibrePlanet 2023
Boston, MA

Elizabeth Chamberlain

19 March 2023

liz@ifixit.com



92,724

free repair manuals



Black and Decker TR1278B Repair

The Black and Decker TR1278B is a wide slot toaster with bagel, frozen, and cancel options as well as seven shade options and a drop-down crumb tray.

Author: Geoff Wacker (and 5 other contributors)

Create a Guide

I Have This

Guides

Replacement Guides

Bread Grabber Spring



Circuit Board



Lever Catch Spring



Top Cover



John Deere 870 Oil Change

Written By: [David Hodson](#) (and 6 other contributors)

Comments: 5

Favorites: 23

Completions: 8



Difficulty Moderate

Steps 15

Time Required [Suggest a time](#) ??

Sections 1

Flags 0

Introduction

Change your tractor's engine oil and filter every 100 hours of use to keep your crops coming season after season.



JOHN ...
WAS H.S.O.

P
USPS PRIORITY MAIL®
fixit
MAILING LABEL
CALL FOR HELP: 1-800-453-4531
© 2011 USPS. SEE US AT USPS.COM

POWERBOOK G3 PISMO
REPAIR

Guides

Replacement

Support Questions

Tools

Details

Troubleshooting

Upgrades

Identification and Background

Additional Information



PowerBook G3 Pismo Repair

Model M7572 / 400 or 500 MHz G3 processor

Author: Miroslav Djuric (and 7 other contributors)

Create a Guide

I Have This

Guides

Replacement Guides

Airport Card		Clutch Cover		Display	
Framework		FEATURED Hard Drive		Heat Shield	
Heat Sink		I/O EMI Shield		Inverter	
Keyboard		Logic Board		Lower Case	
Modem		Optical Drive		PC Card Cage	
PRAM Battery		Power Card		Processor	
FEATURED RAM		Sound Card		Upper Case	

Community

How this Works

Join the Community

Community

Participate

Translate

Leaderboard

Teams

Businesses

Patrol

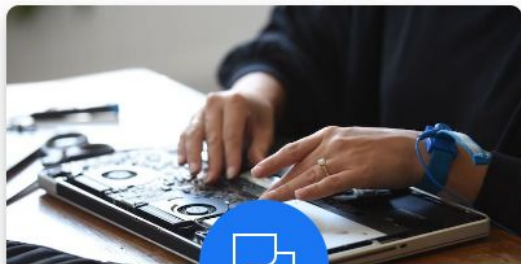

Solve Problems

Get help from friendly fixers and share a helping hand with others around the world.

Answers Forum



Improve iFixit

Help us improve how-to guides that others have started and become a guardian of good quality.

Improve Guides



Help Translate

Translate iFixit into your mother tongue and make repair information available to everyone!

Start Translating

Step 4 Heat Shield

Edit

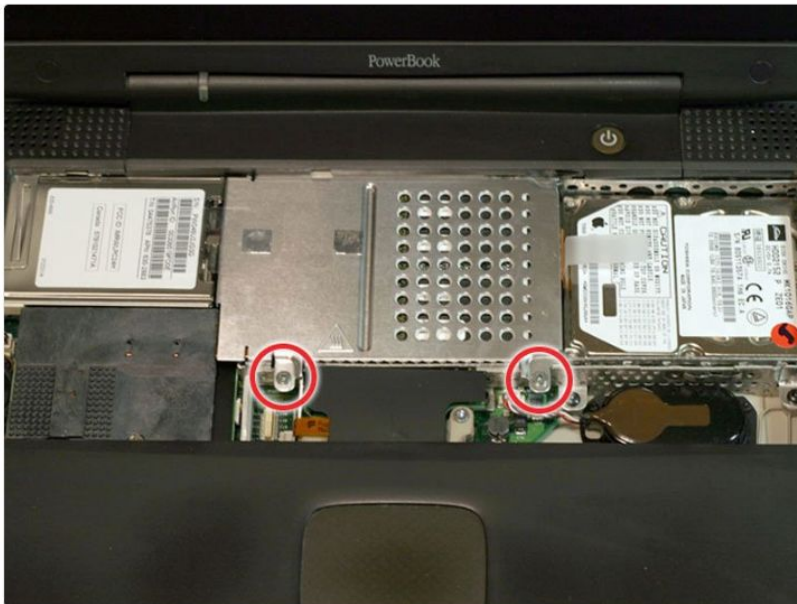

- Remove the two silver Phillips #1 screws that attach the heat shield to the internal metal framework.
- Lift the heat shield up and pull it toward you.

One comment

Add a comment

On my M7572, these are T9s not Phillips.

Rufleyboy - May 5, 2010

Introduction

Details

Guide Steps

Editing Step 2 — Add a title

Notice: You are now editing a prerequisite to the guide you were just viewing. Any changes you make will affect all [4 guides](#) that include this step.

Step Type: 

 Image

 Media



- Remove the sprocket guard plate.

Save



Drag to rearrange

 Delete Step

 Insert Step

Steps

 Rearrange



Privacy

 Public

Private 

Licensing

All iFixit content is licensed under the [Creative Commons BY-NC-SA 3.0](#) license.

All Parts

Quality ensured replacement parts for DIY repair

Repair with confidence! iFixit has you covered with parts, tools, and free repair guides. All of our replacement parts are tested to meet rigorous quality standards and are backed by our industry-leading guarantee.

Choose a model



Mac Parts



iPhone Parts



Android Phone
Parts



PC Laptop Parts



Game Console Parts



iPad Parts



Android Tablet
Parts



iPod Parts



Chromebook Parts



Other Electronics
Parts

iPod Classic Teardown

Published: September 24, 2009

Comments: 7

Favorites: 141

Views: 286.7k

Tools Featured in this Teardown



iFixit Opening Tool
\$1.99

Buy

Introduction

We disassembled this iPod on September 7, 2007.

This teardown is not a repair guide. To repair your iPod Classic, use our [service manual](#).

Step 1 iPod Classic Teardown



- Apple ships two new iPods on the same day, and we take apart two new iPods on the same day (well, the same shift).
- We title this picture, "rising to the challenge."





Step 1 Battery

Edit



- ⓘ Apple designed their new iPods to be very difficult to take apart without destroying major components. Because of the metal faceplate, the metal backing, and the 13 (yes, 13) metal clips holding the case together, this is one of the toughest iPods to disassemble.
- ⚠ Proceed with caution and the warning that you may significantly damage your iPod beyond its present condition. Also, you may want a few extra pairs of plastic opening tools during installation, as they are easy to ruin when opening the iPod. Have fun!
- ⓘ Before opening your iPod, ensure that the hold switch is in the locked position.

Final Thoughts

- ✓ Displays and back glass covers can be replaced without disassembling any other components.
- ✗ Batteries are glued and require extensive disassembly to service.
- ✗ The USB-C port is soldered directly to the main board.
- ✗ Uncommon tri-point screws secure key components.
- ✗ Delicate OLED panels are not well protected from accidental prying, yet must be removed for most repairs.
- ✗ Stubborn glue at all entry points complicates any repair attempt.

Repairability Score



Repairability 2 out of 10
(10 is easiest to repair)

I FIXIT COLLABORATION TIMELINE



RIGHT TO REPAIR

**If you bought it,
you own it—and you
should be able
to fix it.**

On last season of

RIGHT TO REPAIR

On last season of Right to Repair

WINS?



25 November 2022

New EU rules for smartphones and tablets: still far from a true Right to repair

Reaction from Right to Repair Europe on the still unpublished new ecodesign rules for smartphones and tablets. A positive step, but far from a real Right to Repair

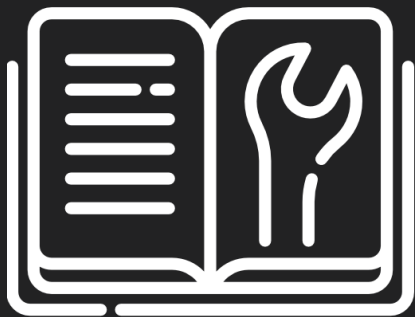

7 years



5 years

cool, but

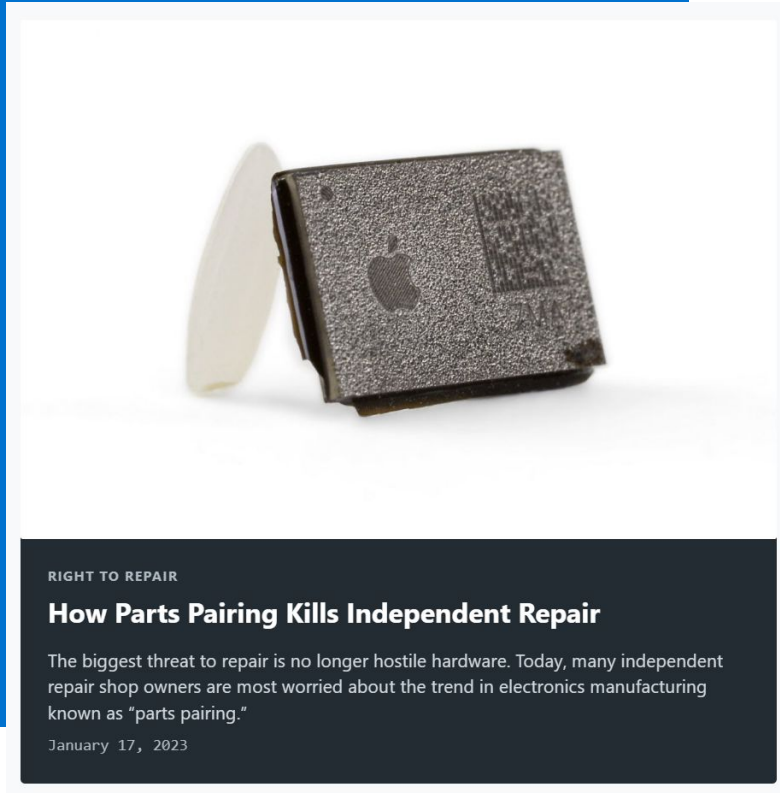

cool, but



On last season of Right to Repair

WINS?



ACTIVISM

New York Passes Historic Right to Repair Bill

The world's first comprehensive right to repair bill has finally been signed into law by New York Governor Kathy Hochul, over six months after it passed the legislature nearly unanimously....

December 29, 2022 by Kyle Wiens

cool, but



Discussing Kathy Hochul's butchering of right to repair with News10's Amal...

Louis Rossmann ✓

105K views • 3 weeks ago

cool, but



Consumer
Technology
Association™

assemblies



Item # IF358-031-4

Samsung Galaxy S21 5G (USA) Screen and Battery - Genuine

\$160.99

★★★★★ 5 | 2 reviews





Everything You Need to Know About Exploding Batteries



Copy link

EXPLODING BATTERIES



Watch on  YouTube



cool, but

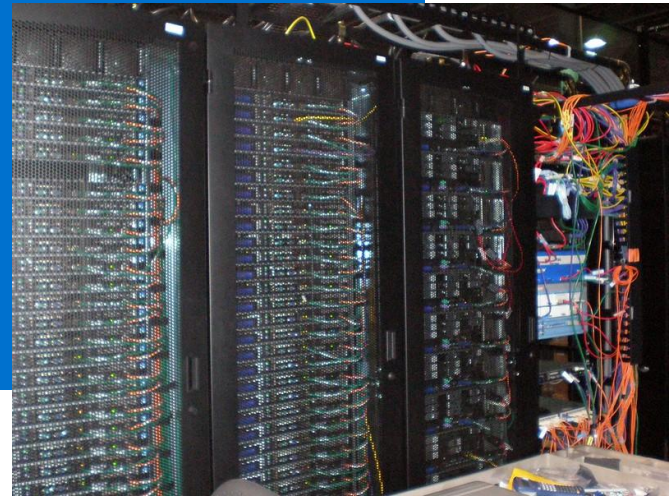

goal #1

**parity with
manufacturer
repair**

On last season of Right to Repair

WINS?

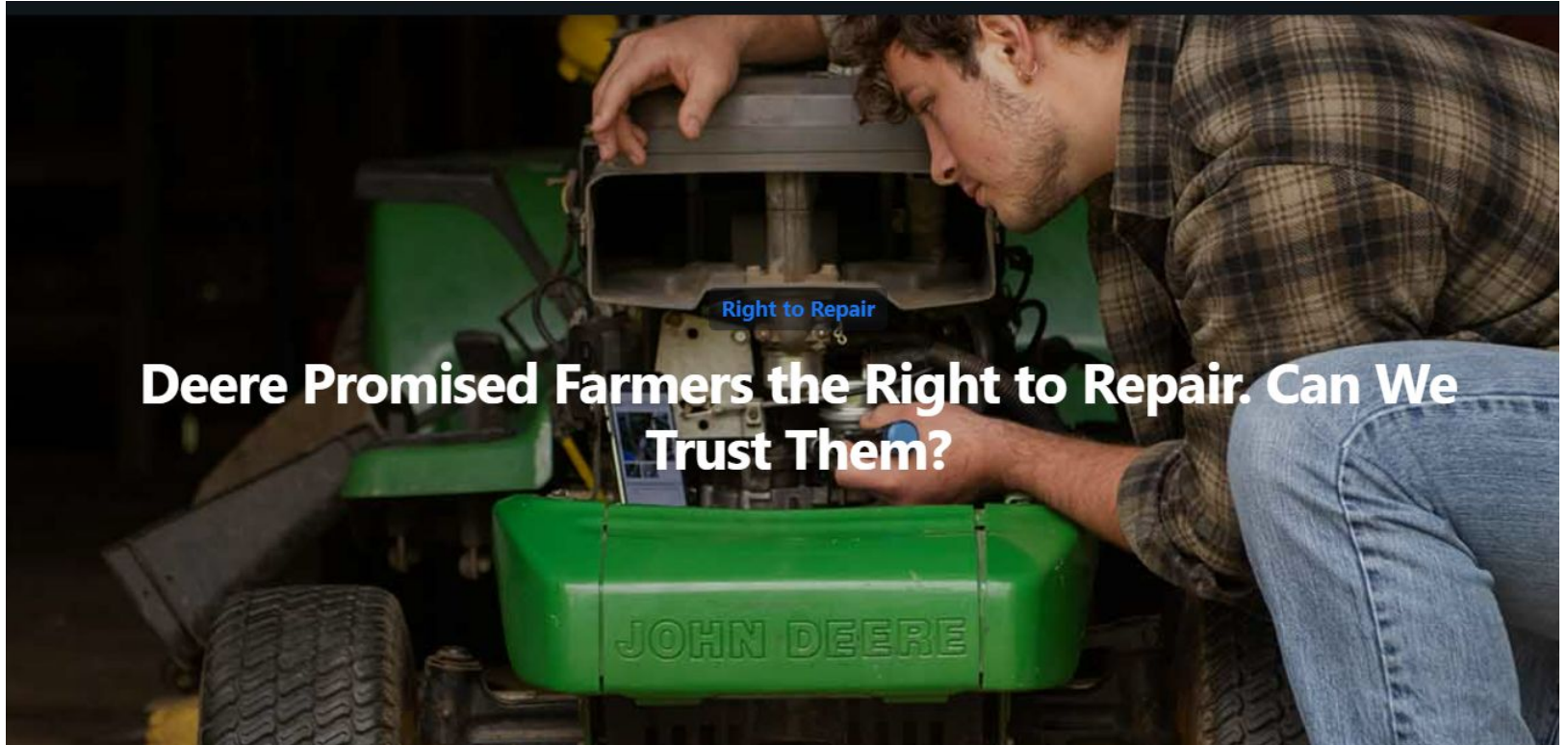

cool, but



cool, but

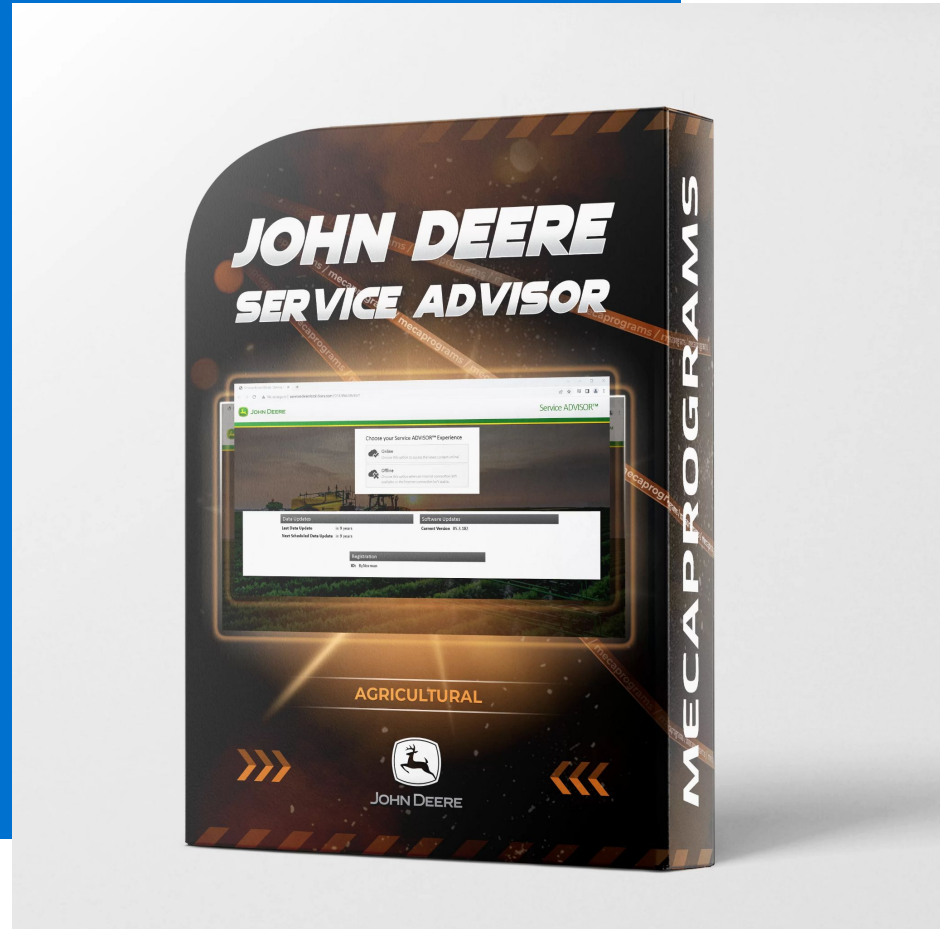

Success



what people think
it looks like

Success



what it really
looks like

Label

Colour corresponds to level of reparability in 2 point intervals



INDEX
8900

 **8,7**
/10
INDICE DE RÉPARABILITÉ

Les paramètres de calcul de l'indice de réparabilité sont disponibles sur la page du produit concerné sur Boulanger.com ou auprès d'un conseiller.

Garantie 2 ans
Indépendamment de la garantie commerciale Boulanger, vous bénéficiez des garanties légales (conditions dans Boulanger.com vous informe à l'entrée du magasin)
Pièces détachées : Pendant 10 ans, à compter de la date d'achat 0001150401

LAISSER À FROID



Premiers de laver avec l'eau spécifique pour bébé et bébé sécurisé

VITESSE PROFESSIONNELLE 1200 tr/min

ÉNERGIE ÉCONOMIQUE B



3000 mm

**REPAIR WINS IN THE
EU BATTERY
DIRECTIVE!**



**RIGHT TO
REPAIR**



22 December 2022

The EU battery directive will make it easier to replace batteries

We celebrate an important repair win on part pairing: this directive finally bans software tricks which hinder the replacement of batteries. We regret however, that an exemption for products used in wet conditions leaves many products such as electric toothbrushes with hardly replaceable batteries.

Jan 23, 2023 - Technology

Flood of "right to repair" bills signals DIY watershed



Peter Allen Clark

- Bills Passed
- Active Right to Repair Bill - 2023
- ▨ Right to Repair Bill Introduced Historical
- No Right to Repair

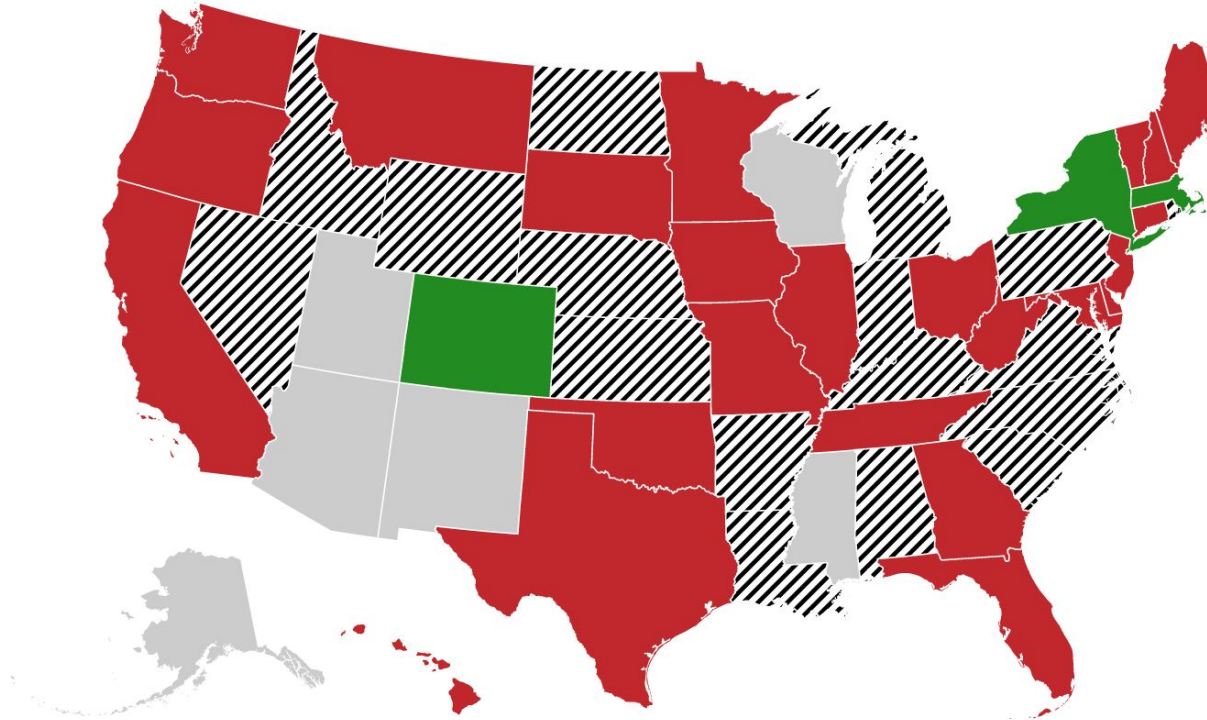





First Regular Session | 74th General Assembly

Colorado General Assembly

HB23-1011

Consumer Right To Repair Agricultural Equipment

software often blocks repair





[How does this website work?](#)
Subscribe for more cool projects like this [here](#)



is the mcdonald's
ice cream
machine broken?



854 Langford Parkway
Langford



2445 Millstream Road
Victoria



1742 Island Hwy
Victoria



1149 Esquimalt Road
Esquimalt



4410 West Saanich Road
Victoria



(Wal-Mart) 3460 Saanic...

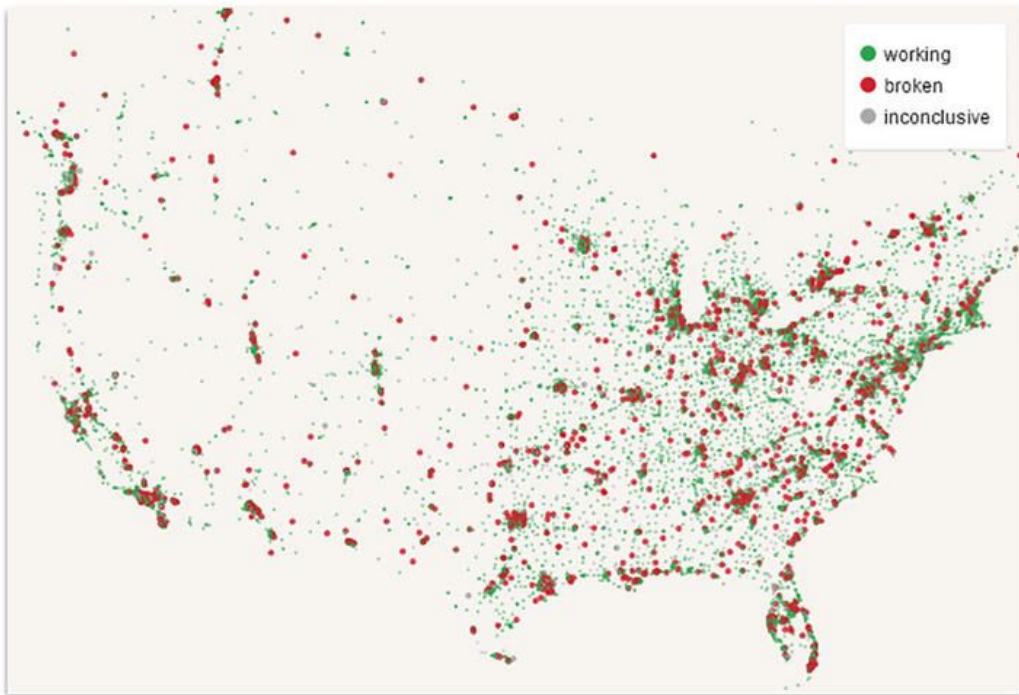

11%
Currently Broken

28.57%
in New York

16.54%
in Houston

15.25%
in Phoenix

15%
in Dallas

13.33%
in San Francisco

LOCKOUT HISTORY 4
12/26/79 19:18
R BRL>41F AFTER SL
> Exit

 TAYLOR®

 14



Kytch™

Built with Raspberry Pi inside.

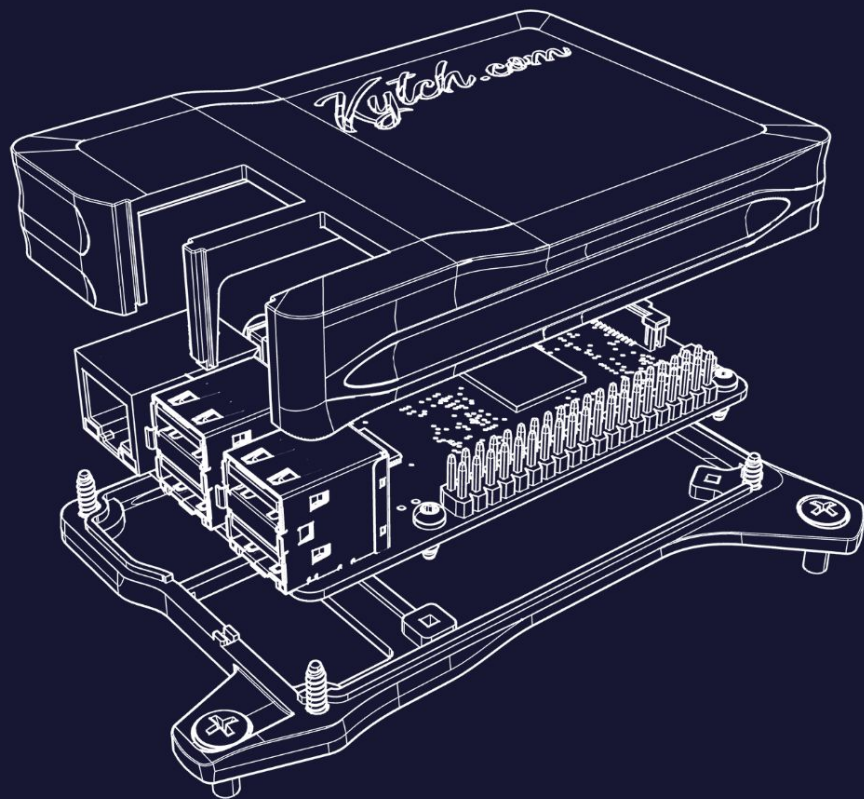



AT YOUR **SERVICE**

We know your equipment represents your livelihood, so we take service and support to another level. Wherever you're located, whatever your specialty, we're here to keep you up and running.

ANDY GREENBERG

SECURITY MAR 2, 2022 7:01 AM

Ice Cream Machine Hackers Sue McDonald's for \$900 Million

Kytch alleges that the Golden Arches crushed its business—and left soft serve customers out in the cold.



Weather

Calendar



FaceTime



Calendar



Photos



Camera

Important Battery Message

Unable to verify this iPhone has a genuine Apple battery.

Settings

OK



Mail



Clock



News



TV

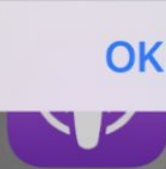

Podcasts



App Store



3

iPhone parts pairing is getting worse

Each model has had more serialized parts

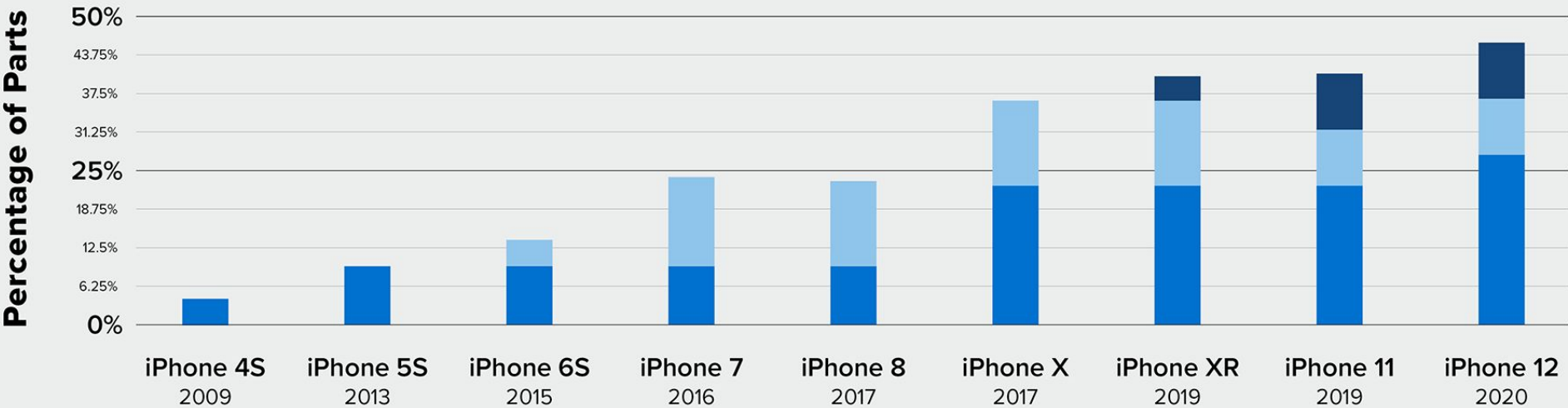

iPhone Model and Year Released

Serialized and not replaceable

Serialized and reprogrammable

Serialized and not reprogrammable

It's not just Apple

Lots of products limit repair through paired parts.



Chainsaws

Only dealers can update firmware on new parts for Husqvarna chainsaws and automowers.



TVs

On many TVs, mainboards, t-con modules and panels must be paired via a hidden routine.



Xbox One

The Xbox disc drive is paired to the motherboard, so replacing one means replacing both.



PS4/PS5

Sony took a cue from Microsoft and also paired the PlayStation disc drive with the motherboard.



Food Processors

When a Thermomix food processor throws an error, only official Vorwerk technicians can get the software to reset it.

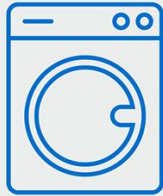

Washing Machines

Many appliances require access to expensive manufacturer software to calibrate replacement parts.



Cars

Some parts are VIN locked, or paired to a car's serial number, requiring a dealer to program replacement parts.



Tractors

Replacing some parts on John Deere tractors requires dealers to input a code to get the tractor out of "limp mode."



How Many PS4's Can I Stack? - Why We Need Right to Repair



TronicsFix ✓
1.36M subscribers

Join

Subscribe

9.8K



Share

Download



“I worked in a call center that provided technical support to a gaming console with a high failure rate, and

if we saw that customers tampered with their devices physically or by software, we denied service on the hardware,

even if the customer was willing to pay.”



Jorge Almazan



Hacking the Xbox

An Introduction to Reverse Engineering

Andrew "bunnie" Huang



When DRM Comes For Your Wheelchair

BY CORY DOCTOROW | JUNE 7, 2022





WHEELCHAIR RIGHT TO REPAIR

93%

Of wheelchair users have **needed their chairs serviced** in the last year



Many repairs take **7 weeks or longer**



One of the biggest challenges is the **long wait for service and parts**

83%

Responded by saying that the **new law would “make life better for wheelchair owners”**



It's Now Okay to Bypass DRM Software to Fix Gadgets, but Right-to-Repair Fight Isn't Over

Consumer rights advocates praise a U.S. Copyright Office decision, while hoping for state legislation

By Nicholas De Leon
October 26, 2018

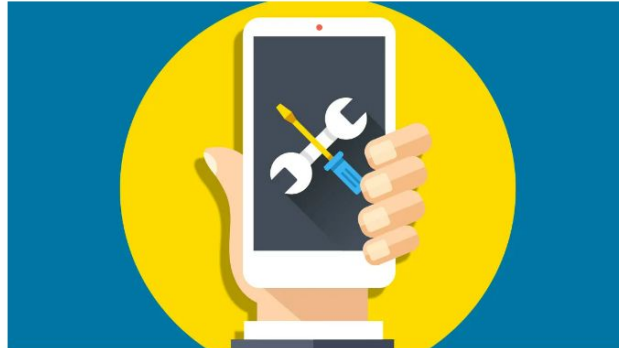





Hacking Keurig 2.0 DRM

Watch later

Share



Kate Gray

@KateGrayCode

129 subscribers

MORE VIDEOS



0:51 / 1:58



YouTube





Liberate the appliances! Washing machine hacker outsmarts anti-repair measures - Week in Repair

Tractor Hacking

[About](#) [PolyCAN](#) [GreenBoard](#) [Documentation](#) [Raw Data](#) [Contributors](#) [User Manual](#)

Welcome to the Tractor Hacking team site

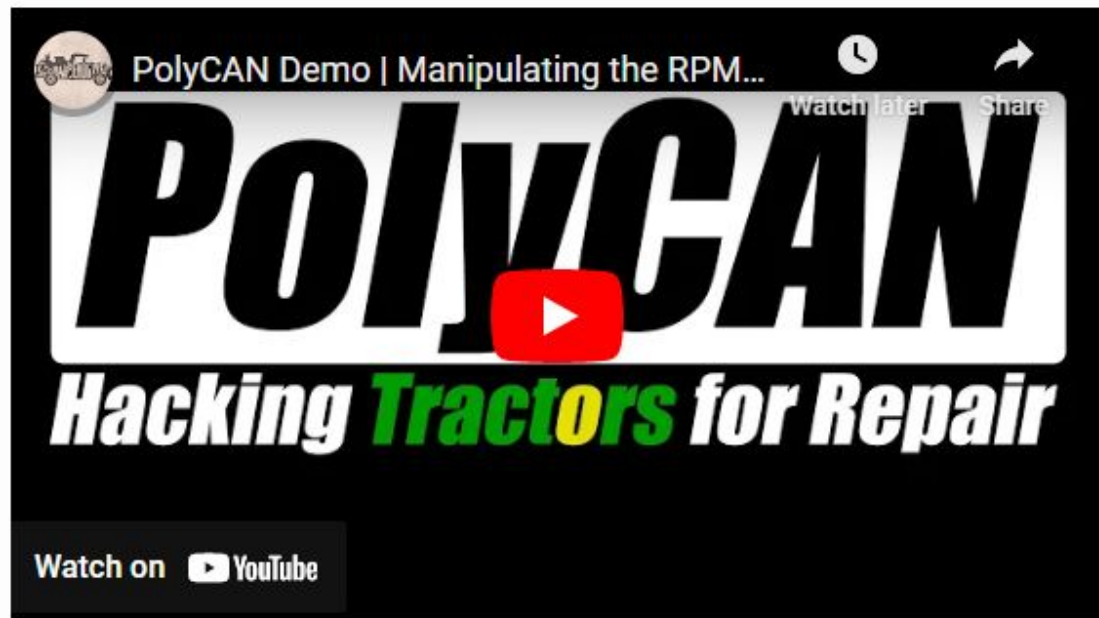





Pin no.	Allocation
A	ECU_GND
B	Unswitched Power ^a
C	Tractor Bus CAN_H
D	Tractor Bus CAN_L
E	Not Specified ^b
F	Not Specified ^c
G	Not Specified ^c
H	Implement Bus CAN_H
J	Implement Bus CAN_L

^a A direct connection to positive battery power through a 10A fuse.

^b Used for the shield of an SAE J1939 network in an SAE diagnostic connector.

^c Used for SAE J170B network in an SAE diagnostic connector.

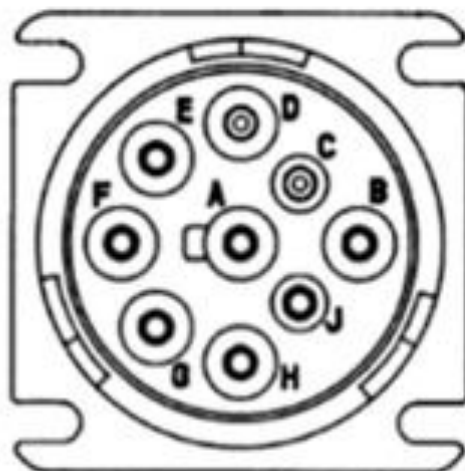



File Edit View Search Terminal Help

```
1486
31.581867694854736,65097,255,71,3,FF FF FF FF FF FF FF FF

1487
31.58286738395691,65091,255,71,3,00 00 FF FF 3F FF FF FF

1488
31.583439588546753,65092,255,71,3,00 00 FF FF 3F FF FF FF

1489
31.583954095840454,65534,255,6,3,5C 20 1C 20 1C FF FF FF

1490
31.58507990837097,61444,255,0,3,F0 FF AA 0A 1C FF FF FF

1491
31.595858097076416,61443,255,0,3,FF 00 32 FF 00 FF FF FF

1492
31.59759497642517,61184,255,0,3,64 06 50 7D FF FF FF FF

1493
31.600759506225586,126720,6,3,3,01 01 FF FF FF FF FF F5

1494
31.60231876373291,61184,0,6,1,64 15 1A F0 02 19 10 0E

1495
31.60365104675293,61444,255,0,3,F0 FF AA 0C 1C FF FF FF

1496
31.61413288116455,61443,255,0,3,FF 00 32 FF 00 FF FF FF

1497
31.61436891555786,61184,255,0,3,64 06 50 7D FF FF FF FF

1498
31.614870309829712,65266,255,0,6,2F 00 FF FF FF FF FF FF

1499
```

MORE VIDEOS

Diagnostic Trouble Code	Display	Solution
PTI 524238.31 	Transmission Lever Not in Park	Left-Hand Reverser Lever Not in Park or Neutral at Power Up. Place lever in park or neutral. Restart vehicle. If code returns, have John Deere dealer repair at earliest convenience.



Press **Esc** to exit full screen



```
pol
File Edit View Search Terminal Help
Sent: 2480 Recv: 3927
103.93508982658386,61443,255,0,3,FF 00 00 FF 00 FF FF FF
Sent: 2481 Recv: 3928
103.93542575836182,61184,255,0,3,64 06 00 7D FF FF FF FF
Sent: 2482 Recv: 3929
103.9363067150116,61184,250,0,6,64 01 FF 00 00 FF FF FF
Sent: 2483 Recv: 3930
103.93753600120544,126720,6,3,3,01 01 FF FF FF FF FF F5
Sent: 2484 Recv: 3931
103.94149231910706,61184,0,6,1,64 15 1F F0 CD 16 10 0E
Sent: 2485 Recv: 3932
103.94474506378174,65097,255,71,3,FF FF FF FF FF FF FF FF
Sent: 2486 Recv: 3933
103.94546508789062,65128,255,71,6,34 FF FF FF FF FF FF FF
Sent: 2487 Recv: 3934
103.95207238197327,65091,255,71,3,00 00 FF FF 3F FF FF FF
Sent: 2488 Recv: 3935
103.95254230499268,65535,255,6,6,73 FF FF FF FF FF FF FF
Sent: 2489 Recv: 3936
103.95945048332214,65092,255,71,3,00 00 FF FF 3F FF FF FF
Sent: 2490 Recv: 3937
103.96098923683167,65531,255,6,6,00 05 7D F8 FF FF FF FF
Sent: 2491 Recv: 3938
103.96143555641174,61444,255,0,3,F0 FF 7D 00 00 FF FF FF
Sent: 2492 Recv: 3939
103.96190214157104,61443,255,0,3,FF 00 00 FF 00 FF FF FF
Sent: 2493
```

tractorhacking.github.io

CAL POLY NEWS

BROWSE CATEGORIES ▾

DIVERSITY, EQUITY AND INCLUSION

CALIFORNIA IMPACT

SHARE A STORY IDEA

CALIFORNIA IMPACT

Could These Students Improve the Global Food Supply? They're Finding Out — One Tractor at a Time



WRITTEN BY ROBYN KONTRA TANNER // PHOTOS BY JOE JOHNSTON | JULY 26, 2021

← Thread

*SICK.
CODES* Sick.Codes ✓
@sickcodes

Playing Doom on a John Deere tractor display (jailbroken/rooted) at @defcon



11:10 AM · Aug 14, 2022

981 Retweets 181 Quotes 3,633 Likes



TECH / ENTERTAINMENT / GAMING

Def Con hacker shows John Deere's tractors can run Doom



/ Mow down your enemies

By **EMMA ROTH**
Aug 15, 2022, 3:11 PM PDT | [0 Comments](#) / [0 New](#)



Security researcher Sick Codes got Doom to run on a John Deere display. Photo by PATRICK T. FALLON / AFP via Getty Images

LILY HAY NEWMAN

SECURITY AUG 13, 2022 9:31 PM

A New Jailbreak for John Deere Tractors Rides the Right-to-Repair Wave

A hacker has formulated an exploit that provides root access to two popular models of the company's farm equipment.



PHOTOGRAPH: PAUL HARRIOTT/ALAMY



Kevin Kenney, prairie provocateur. *Photographer: Walker Pickering for Bloomberg Businessweek*

Bloomberg

US Edition ▾ Your Account 

● Live Now Markets Economics Industries Technology Politics Wealth Pursuits Opinion **Businessweek** Equality Green CityLab Crypto More ▸

Businessweek | Feature

Farmers Fight John Deere Over Who Gets to Fix an \$800,000 Tractor

The right-to-repair movement has come to the heartland, where some farmers are demanding access to the software that runs their equipment.

By [Peter Waldman](#) and [Lydia Mulvany](#)

March 5, 2020 at 2:00 AM PST

GNU Public License

For example, if you distribute copies of such a program, whether gratis or for a fee, you must pass on to the recipients the same freedoms that you received. You must make sure that they, too, receive or can get the source code. And you must show them these terms so they know their rights.



Let's save the GNU!

gpl-violations.org

gpl-violations.org project prevails in court case on GPL violation by D-Link

Harald Welte — 2006-09-22

D-Link®



DIR-3040

Quick Install Guide

GPL Code Statement

This D-Link product includes software code developed by third parties, including software code subject to the GNU General Public License ("GPL") or GNU Lesser General Public License ("LGPL"). As applicable, the terms of the GPL and LGPL, and information on obtaining access to the GPL code and LGPL code used in this product, are available to view the full GPL Code Statement at:

<https://tsd.dlink.com.tw/GPL>

The GPL code and LGPL code used in this product is distributed WITHOUT ANY WARRANTY and is subject to the copyrights of one or more authors. For details, see the GPL code and the LGPL code for this product and the terms of the GPL and LGPL.

Written Offer for GPL and LGPL Source Code

Where such specific license terms entitle you to the source code of such software, D-Link will provide upon written request via email and/or traditional paper mail the applicable GPL and LGPL source code files via CD-ROM for a nominal cost to cover shipping and media charges as allowed under the GPL and LGPL.

Please direct all inquiries to:

Email:

GPLCODE@dlink.com

Snail Mail:

Attn: GPLSOURCE REQUEST
D-Link Systems, Inc.
17595 Mt. Herrmann Street
Fountain Valley, CA 92708



[< News](#)

FSFE compliance workshop discovers GPL violation by FANTEC, Welte wins in court

on: 2013-06-26



Consumer electronics & home office equipment

- *Home cinema - 3D Full HD Media Player*
- *Storage devices*
- *Action cameras*
- *HiFi audio*
- *Accessories for mobile devices*



FREE SOFTWARE
FOUNDATION

www.fsf.org





I found a vulnerability in your proprietary mobility stack
enabling unauthorized remote control over Bluetooth.

 Share |  Read More



Everyone should have the right to run, study,
fix and share software they use.

 Share |  Read More



LIBREPLANET

[About](#) ▾

[Teams](#) ▾

[Conferences](#) ▾

[Get involved](#) ▾

[Login](#)



Group: **FSF/Fight-to-Repair**

[< Group:FSF](#)

[CONTENTS](#) to top

[What is Right to Repair](#)



software freedom
conservancy



DONATE

HOME WHAT WE DO WHO WE ARE LEARN NEW

Software Freedom Conservancy files right-to-repair lawsuit against California TV manufacturer Vizio Inc. for alleged GPL violations

Litigation is historic in nature due to its focus on consumer rights, filing as third-party beneficiary

FOR IMMEDIATE RELEASE

IRVINE, Calif. (Oct. 19, 2021) Software Freedom Conservancy announced today it has filed a lawsuit against Vizio Inc. for what it calls repeated failures to fulfill even the basic requirements of the General Public License (GPL).





APPLICATIONS

54

GPL legal battle: Vizio told by judge it will have to answer breach-of-contract claims

Fine-print crucially deemed contractual agreement as well as copyright license in smartTV source-code case

[Thomas Claburn](#)

Mon 16 May 2022 // 23:36 UTC

The Software Freedom Conservancy (SFC) has won a significant legal victory in its ongoing effort to force Vizio to publish the source code of its SmartCast TV software, which is said to contain GPLv2 and LGPLv2.1 copyleft-licensed components.

After 2 years and more than a dozen ignored GPL source code requests,

**SFC called
Deere out
publicly this
week.**



Software Freedom Conservancy Launches Self-Service Copyright Assignment Process

Developers Can Dedicate their Copyrights to Charity to Assure Software Rights

May 2, 2022



sfconservancy.org/assignment/



You deserve the right to repair your stuff

1,739,868 views | Gay Gordon-Byrne • TEDMonterey

[Share](#) [Add](#) [Like \(52K\)](#)

[Read transcript](#)

A self-declared "repair geek," Gay Gordon-Byrne is a driving force behind the right-to-repair movement, which aims to empower people to fix their stuff. She describes how the movement is gaining legislative momentum and breaks down how the global shift away from "throwaway society" can literally turn trash into treasure in a circular economy -- so we can all experience that "Yes! I fixed it!" feeling.

About the speaker



Gay Gordon-Byrne
Right-to-repair advocate

[See speaker profile >](#)

Gay Gordon-Byrne fights for your right to repair the consumer goods you buy.

[your state].repair.org

Dear Bay Staters,

It's time to speak out for your right to repair

Massachusetts is already leading the world in repair, by passing the first-ever Right to Repair bill in 2012, for automobiles.

It's time to guarantee that Bay Staters can fix everything they own. This year, MA is considering two bills: HD 3826 and SD 793, which would give Massachusetts the right to fix cell phones and tablets.

Your legislators need to hear why repair matters to you—what have you tried to fix but couldn't? How have parts, tools, and repair documentation limitations made your life or business more difficult?

Use the form below to call or write your legislators—we'll track down their contact information.

Tell your repair story

ENTER YOUR RETURN ADDRESS

First Name *	<input type="text"/>	<input type="checkbox"/>	START WRITING
Last Name *	<input type="text"/>	<input checked="" type="checkbox"/>	
Email *	<input type="text"/>	<small>Opt in to email updates from The Repair Association</small>	
Street Address *	<input type="text"/>		
City *	<input type="text"/>		
Zip/Postal Code *	<input type="text"/>		
<small>Not in US?</small>			

** This form does not work for addresses outside of Massachusetts — and may not work for some rural addresses. If you cannot use this form, do not be deterred. Look up your local Massachusetts representative the old-fashioned way, tell them you support Fair Repair, and tell them why. **

RIGHT TO REPAIR



Right to Repair

Want the right to repair your stuff? We are working to get Apple, John Deere and other companies to provide access to the information, tools and parts we need.



Companies don't make things like they used to, and that's a big problem. Not long ago, most consumer goods and business products were easily

After years of advocacy, Apple reversed its longstanding policy against making spare parts, repair instructions and repair software tools available to customers in 2021.



NEW ECONOMY

Let us fix our stuff

We should give every consumer and every small business access to the parts, tools, and service information they need to repair products by passing Right to Repair reforms.

[SIGN THE PETITION](#)



fighttorepair.substack.com



fight
to
repair
weekly

Fight to Repair

Weekly dispatches from the front lines of the global fight for the right to repair. Written and curated by Paul Roberts, the founder of SecuRepairs.org and Editor at The Security Ledger, and Jack Monahan.

Launched 2 years ago

Subscribe

No thanks >

FUTURE SHOP



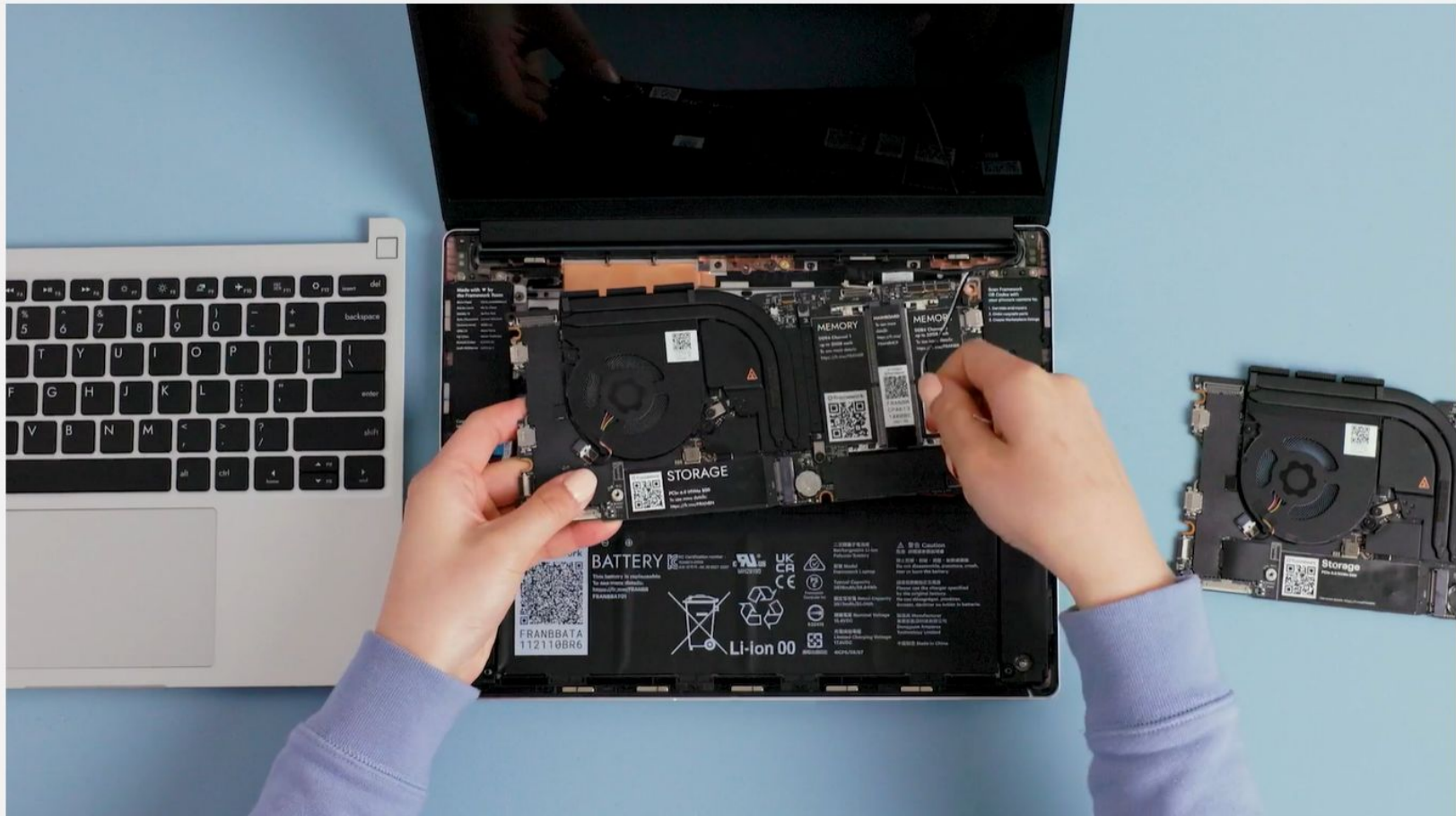

Linux on the Framework Laptop



We designed the Framework Laptop from the outset to be a great Linux laptop, and the [Framework Laptop DIY Edition](#) comes with no OS loaded to let you bring your favorite Linux distribution. We deliberately selected components and modules that didn't require new kernel driver development and have been providing distro maintainers with pre-release hardware to test to improve compatibility. We're also working on enabling firmware updates through LVFS to complete the Linux experience.

Fedora 37 Installation 4.2

m

03/01/2023 by Matt Hartley

Details

Fedora 37 Installation on the Framework Laptop

Written By: [Nirav Patel](#) (and one other contributor)

Comments: 39

Favorites: 2

Completions: 18



Difficulty Easy

Steps 8

Time Required 00:10:00 - 00:20:00

Sections 1

Flags 0



FrameworkComputer / EmbeddedController Public

Notifications

Fork 46

Star 773

Code Issues 8 Pull requests 6 Actions Security Insights

hx20-hx30

6 branches 0 tags

Go to file

Code

About

Embedded Controller firmware for the Framework Laptop

Readme

BSD-3-Clause license

773 stars

20 watching

46 forks

Releases

No releases published



kiram9 Merge pull request #5 from DHowett/hx20

38c1b38 on Jan 4 16,715 commits

.github	Merge pull request #535 from FrameworkComputer/lin...	3 months ago
.vscode	add vscode workspace files	3 years ago
baseboard	Add host command to check privacy switch status (#513)	3 months ago
board	fix i2c controller mapping on TGL	3 months ago
builtin	Replace __attribute__((noreturn)) with noreturn	3 years ago
chip	Merge branch 'hx30' into hx20-hx30	4 months ago
common	Fix: auto brightness decrease curve not smooth enoug...	last year



Camera upgrades for your Fairphone 3

Discover the greener way to get new features

[Discover modules](#)

[How to upgrade](#)



ploopy

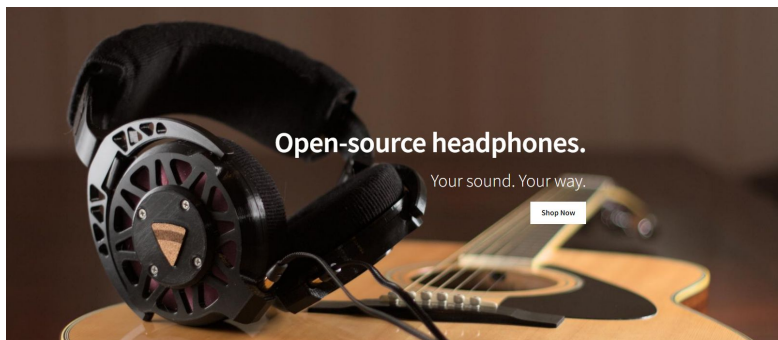

Open-source headphones.

Your sound. Your way.

[Shop Now](#)

Open-source. More choices. More freedom.



Source files for everything are available, for free, forever, without any limits

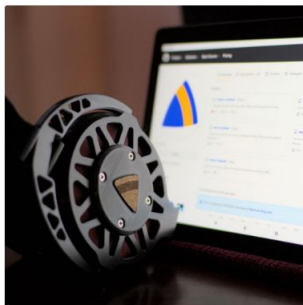

Complete documentation for assembly, modifications, and maintenance

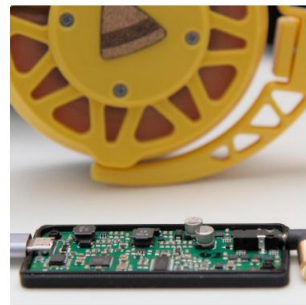

Full transparency on parts, fabrication methods, and how it all works



Contests

Dare to Repair! 3D Printed Repair Parts Contest



Article by:
Kay Kay Clapp
[@kaykay](#)

February 14, 2018
Filed under: Contests
[Add Comment](#)

3D Printing for Repair Guide

Juljeta Bolaños-Arriola, Alma van Oudheusden, Bas Flipsen & Jeremy Faludi



🔧 BEST SPARE PARTS STL FILES FOR REPAIR THANKS TO 3D PRINTING



DOWNLOAD 3D MODELS OF SPARE PARTS

You are looking for your own 3D printable Spare Parts platform? [Contact us](#). This is probably the first use you think of when you think of 3D printing, repairing small broken plastic parts that are impossible to find on the market. In this collection, find enough to repair all the broken objects in your home and give them a second life!

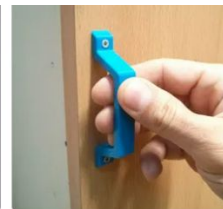

Porsche Can Now 3D-Print Parts For The 959 Supercar

The new components can help Porsche 964 and 356 owners, too.



Feb 12, 2018 at 2:36pm ET

0



By: **Chris Bruce**



Illustration by Alex Castro / The Verge

TRANSP0

The ancient computers in the Boeing 737 Max are holding up a fix

The perils of fixing a hardware problem with software

By **DARRYL CAMPBELL**

Apr 9, 2020, 5:00 AM PDT | [0 Comments](#) / [0 New](#)



TESLA

Tesla Full Self-Driving Beta v11 is coming this weekend, if you believe Elon Musk



Fred Lambert | Mar 15 2023 - 6:25 am PT 🗨️ 117 Comments



After months of waiting, Tesla Full Self-Driving Beta v11 is going to a wide release this weekend, if you believe Elon Musk.

Technology / New Vehicles

Ford patents system for vehicles to repossess themselves

With this tech, if you don't make payments, your Ford could drive itself to the impound lot — or even the scrapyard

Jill McIntosh

Published Feb 28, 2023 • Last updated Mar 01, 2023 • 3 minute read

6 Comments



An August 2015 file photo of tow trucks in Ottawa PHOTO BY MATT DAY /Postmedia files

“In 2025, there will be

55.7 billion

connected IoT devices.”

– KPMG, 20 Predictions for the Next 20 Years

software is everywhere,
and it must be **free**

free to hack
share
repair



Together we can fix any thing.